

# PA98 • PA98A

## FEATURES

- HIGH VOLTAGE — 450V ( $\pm 225V$ )
- HIGH SLEW RATE —  $1000V/\mu S$
- HIGH OUTPUT CURRENT — 200mA

## APPLICATIONS

- HIGH VOLTAGE INSTRUMENTATION
- PIEZO TRANSDUCER EXCITATION
- PROGRAMMABLE POWER SUPPLIES UP TO 430V
- ELECTROSTATIC TRANSDUCERS & DEFLECTION

## DESCRIPTION

The PA98 is a high voltage, high power bandwidth MOSFET operational amplifier designed for output currents up to 200mA. Output voltages can swing up to  $\pm 215V$  with a dual supply and up to +440 volts with a single supply. The safe operating area (SOA) has no second breakdown limitations and can be observed with all types of loads by choosing an appropriate current limiting resistor. High accuracy is achieved with a cascode input circuit configuration. All internal biasing is referenced to a bootstrapped zener-MOSFET current source. As a result, the PA98 features an unprecedented supply range and excellent supply rejection. The MOSFET output stage is biased on for linear operation. External compensation provides user flexibility.

This hybrid circuit utilizes thick film (cermet) resistors, ceramic capacitors and silicon semiconductor chips to maximize reliability, minimize size and give top performance. Ultrasonically bonded aluminum wires provide reliable interconnections at all operating temperatures. The Power SIP package is electrically isolated.

## EQUIVALENT SCHEMATIC

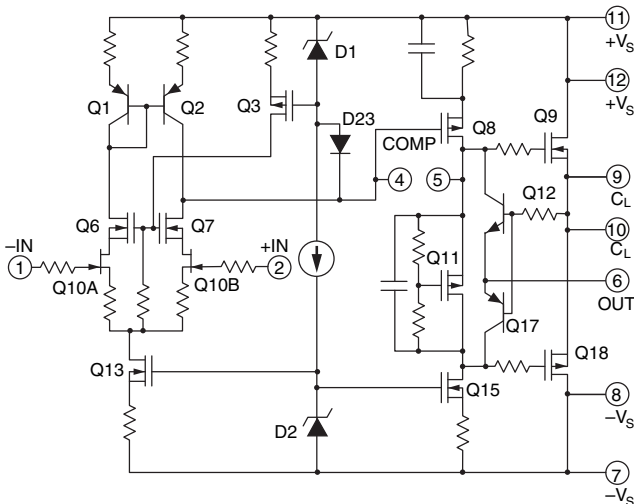

PATENTED

## 12-PIN SIP PACKAGE STYLE DP

Formed leads available  
Package styles ED & EE

## TYPICAL APPLICATION

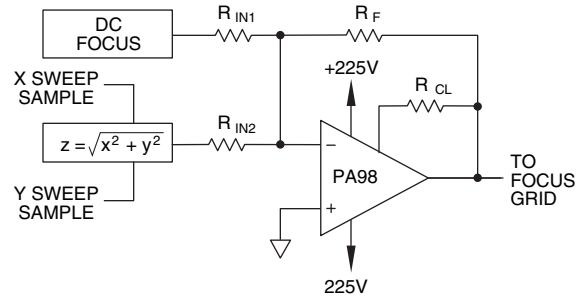

DYNAMIC FOCUSING

Dynamic focusing is the active correction of focusing voltage as a beam traverses the face of a CRT. This is necessary in high resolution flat face monitors since the distance between cathode and screen varies as the beam moves from the center of the screen to the edges. PA98 lends itself well to this function since it can be connected as a summing amplifier with inputs from the nominal focus potential and the dynamic correction. The nominal might be derived from a potentiometer, or perhaps automatic focusing circuitry might be used to generate this potential. The dynamic correction is generated from the sweep voltages by calculating the distance of the beam from the center of the display.

## EXTERNAL CONNECTIONS

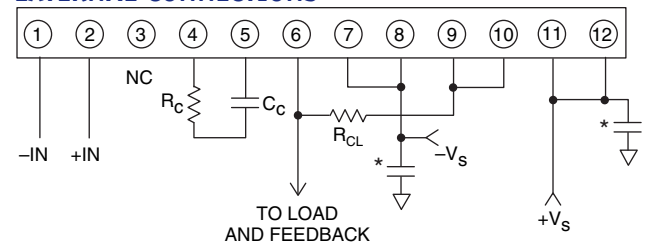

\* Bypassing required.

## PHASE COMPENSATION

Gain	C <sub>c</sub>	R <sub>c</sub>
1	68pF	100Ω
20	10pF	330Ω
100	3.3pF	0Ω

C<sub>c</sub> RATED FOR FULL SUPPLY VOLTAGE

**ABSOLUTE MAXIMUM RATINGS**

SUPPLY VOLTAGE, $+V_s$ to $-V_s$	450V
OUTPUT CURRENT, continuous within SOA	200mA
POWER DISSIPATION, continuous @ $T_c = 25^\circ\text{C}^2$	30W
INPUT VOLTAGE, differential	$\pm 25\text{V}$
INPUT VOLTAGE, common mode	$\pm V_s$
TEMPERATURE, pin solder - 10s max.	260°C
TEMPERATURE, junction <sup>2</sup>	150°C
TEMPERATURE RANGE, storage	-40 to +85°C
OPERATING TEMPERATURE RANGE, case	-25 to +85°C

**SPECIFICATIONS**

PARAMETER	TEST CONDITIONS <sup>1</sup>	PA98			PA98A			UNITS
		MIN	TYP	MAX	MIN	TYP	MAX	
<b>INPUT</b>								
OFFSET VOLTAGE, initial			.5	2		.25	.5	mV
OFFSET VOLTAGE, vs. temperature	Full temperature range		10	30		5	10	$\mu\text{V}/^\circ\text{C}$
OFFSET VOLTAGE, vs. supply			3	10		*	*	$\mu\text{V}/\text{V}$
OFFSET VOLTAGE, vs. time			75			*		$\mu\text{V}/\text{kh}$
BIAS CURRENT, initial <sup>3</sup>			5	50		3	10	pA
BIAS CURRENT, vs. supply			.01			*		pA/V
OFFSET CURRENT, initial <sup>3</sup>			10	100		3	30	pA
INPUT IMPEDANCE, DC			$10^{11}$			*		$\Omega$
INPUT CAPACITANCE			4			*		pF
COMMON MODE VOLTAGE RANGE <sup>4</sup>		$\pm V_s - 15$			*			V
COMMON MODE REJECTION, DC	$V_{CM} = \pm 90\text{V}$	90	110		*	*		dB
NOISE	100kHz BW, $R_s = 1\text{K}\Omega$ , $C_c = 10\text{pf}$		1			*		$\mu\text{Vrms}$
<b>GAIN</b>								
OPEN LOOP, @ 15Hz	$R_L = 2\text{K}\Omega$ , $C_c = \text{OPEN}$	96	111		*	*		dB
GAIN BANDWIDTH PRODUCT at 1MHz	$R_L = 2\text{K}\Omega$ , $C_c = 3.3\text{pf}$		100			*		MHz
POWER BANDWIDTH	$C_c = 10\text{pf}$		300			*		kHz
	$C_c = 3.3\text{pf}$		500			*		kHz
	Full temperature range		60			*		°
<b>PHASE MARGIN</b>								
Full temperature range			60			*		°
<b>OUTPUT</b>								
VOLTAGE SWING <sup>4</sup>	$I_o = \pm 200\text{mA}$	$\pm V_s - 10$	$\pm V_s - 6.5$		*	*		V
VOLTAGE SWING <sup>4</sup>	$I_o = \pm 75\text{mA}$	$\pm V - 8.5$	$\pm V_s - 6.0$		*	*		V
VOLTAGE SWING <sup>4</sup>	$I_o = \pm 20\text{mA}$	$\pm V - 8.0$	$\pm V_s - 5.5$		*	*		V
CURRENT, continuous	$T_c = 85^\circ\text{C}$	$\pm 200$				*		mA
SLEW RATE, $A_v = 20$	$C_c = 10\text{pf}$		400			*		V/ $\mu\text{s}$
SLEW RATE, $A_v = 100$	$C_c = \text{OPEN}$		1000		700	*		V/ $\mu\text{s}$
CAPACITIVE LOAD, $A_v = +1$	Full temperature range	470			*		*	pf
SETTLING TIME to .1%	$C_c = 10\text{pf}$ , 2V step		1			*		$\mu\text{s}$
RESISTANCE, no load	$R_{CL} = 0$		50			*		$\Omega$
<b>POWER SUPPLY</b>								
VOLTAGE <sup>5</sup>	Full temperature range	$\pm 15$	$\pm 150$	$\pm 225$	*	*	*	V
CURRENT, quiescent			21	25		*	*	mA
<b>THERMAL</b>								
RESISTANCE, AC, junction to case <sup>5</sup>	Full temperature range, $F > 60\text{Hz}$			2.5		*	*	$^\circ\text{C}/\text{W}$
RESISTANCE, DC, junction to case	Full temperature range, $F < 60\text{Hz}$			4.2		*	*	$^\circ\text{C}/\text{W}$
RESISTANCE, junction to air	Full temperature range		30			*	*	$^\circ\text{C}/\text{W}$
TEMPERATURE RANGE, case	Meets full range specifications	-25		+85	*		*	$^\circ\text{C}$

- NOTES: \* The specification of PA98A is identical to the specification for PA98 in applicable column to the left.
1. Unless otherwise noted:  $T_c = 25^\circ\text{C}$ , compensation =  $C_c = 68\text{pF}$ ,  $R_c = 100\Omega$ . DC input specifications are  $\pm$  value given. Power supply voltage is typical rating.
  2. Long term operation at the maximum junction temperature will result in reduced product life. Derate internal power dissipation to achieve high MTTF. Ratings apply only to output transistors. An additional 10W may be dissipated due to quiescent power.
  3. Doubles for every  $10^\circ\text{C}$  of temperature increase.
  4.  $+V_s$  and  $-V_s$  denote the positive and negative power supply rail respectively.
  5. Rating applies if the output current alternates between both output transistors at a rate faster than 60Hz.
  6. Derate max supply rating .625 V/ $^\circ\text{C}$  below  $25^\circ\text{C}$  case. No derating needed above  $25^\circ\text{C}$  case.

**CAUTION** The PA98 is constructed from MOSFET transistors. ESD handling procedures must be observed. The exposed substrate contains beryllia (BeO). Do not crush, machine, or subject to temperatures in excess of  $850^\circ\text{C}$  to avoid generating toxic fumes.

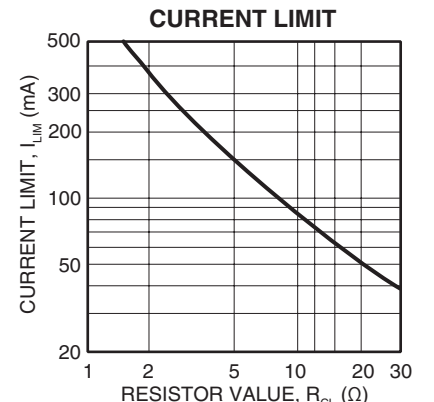
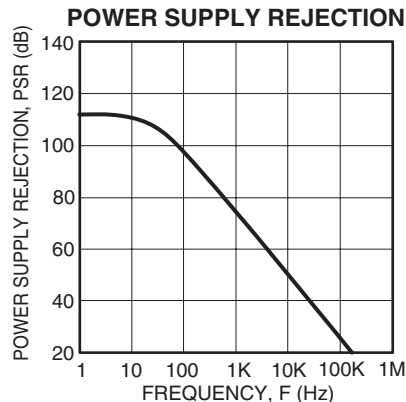
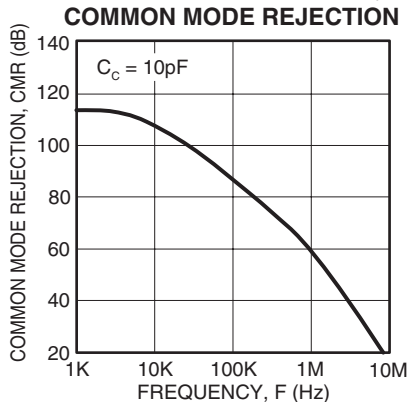
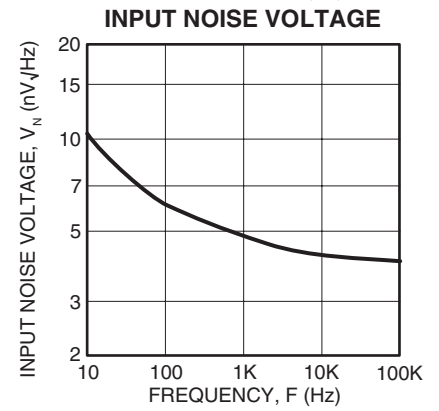
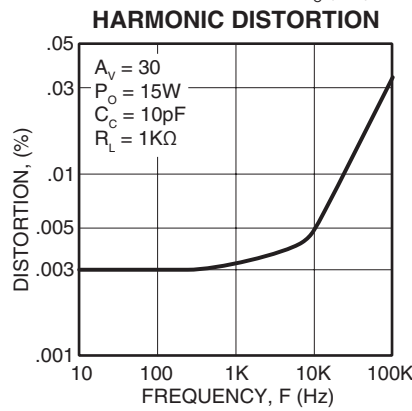
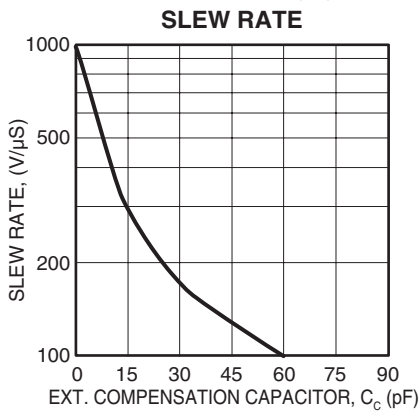
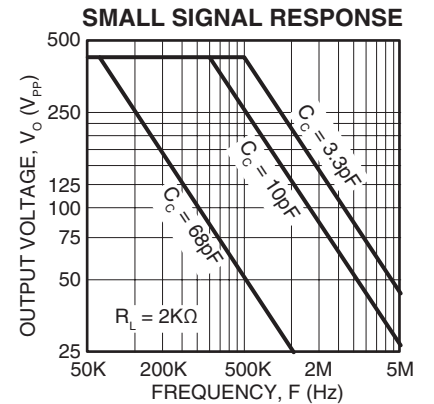
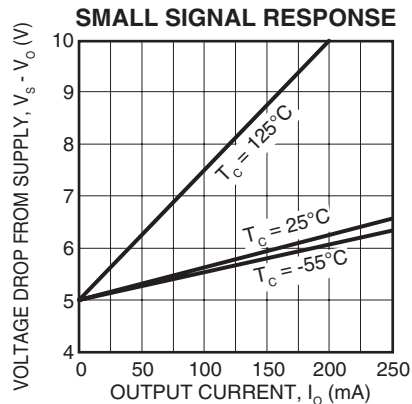
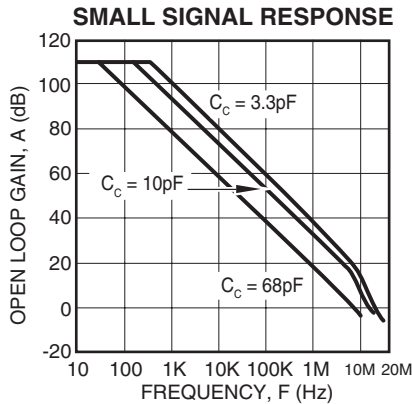
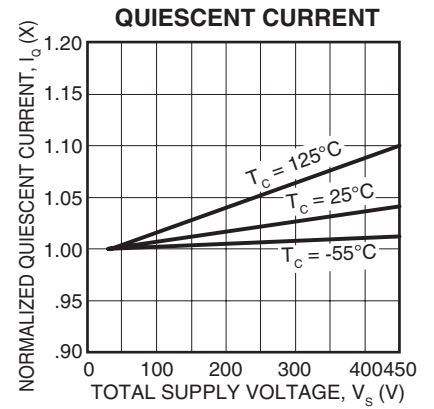
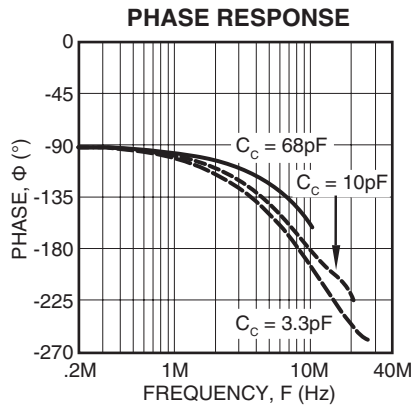
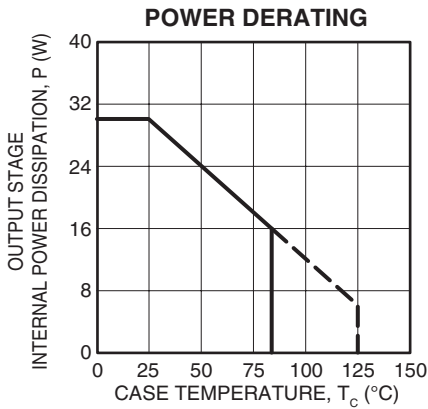

**GENERAL**

Please read Application Note 1 "General Operating Considerations" which covers stability, supplies, heat sinking, mounting, current limit, SOA interpretation, and specification interpretation. Visit [www.apexmicrotech.com](http://www.apexmicrotech.com) for design tools that help automate tasks such as calculations for stability, internal power dissipation, current limit; heat sink selection; Apex's complete Application Notes library; Technical Seminar Workbook; and Evaluation Kits.

**CURRENT LIMIT**

For proper operation, the current limit resistor ( $R_{CL}$ ) must be connected as shown in the external connection diagram. The minimum value is 1.4 ohm, however for optimum reliability the resistor value should be set as high as possible. The value is calculated as follows; with the maximum practical value of 30 ohms.

$$R_{CL} = \frac{.7}{I_{LIM} - .016}$$

**SAFE OPERATING AREA (SOA)**

The MOSFET output stage of this power operational amplifier has two distinct limitations:

1. The current handling capability of the MOSFET geometry and the wire bonds.
2. The junction temperature of the output MOSFETs.

NOTE: The output stage is protected against transient flyback. However, for protection against sustained, high energy flyback, external fast-recovery diodes should be used.

**SAFE OPERATING CURVES**

The safe operating area curves define the maximum additional internal power dissipation the amplifier can tolerate when it produces the necessary output to drive an external

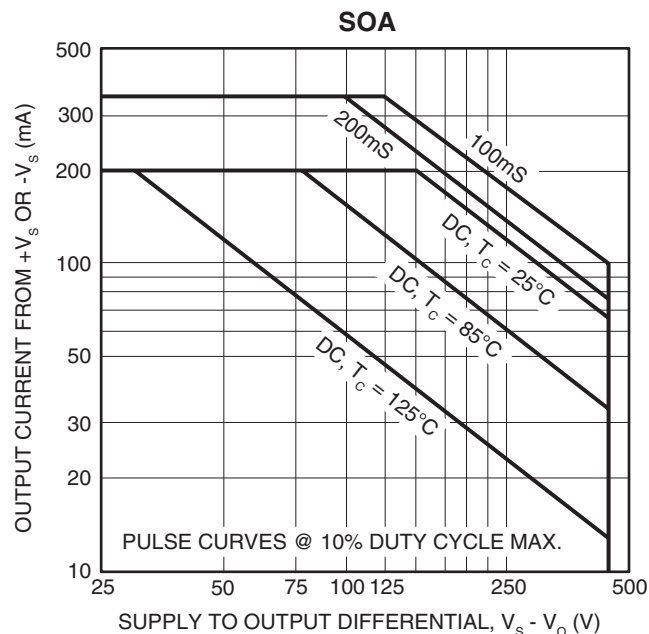

load. This is not the same as the absolute maximum internal power dissipation listed elsewhere in the specification since the quiescent power dissipation is significant compared to the total.

**INPUT PROTECTION**

Although the PA98 can withstand differential voltages up to  $\pm 25V$ , additional external protection is recommended. Since the PA98 is a high speed amplifier, low leakage, low capacitance JFETs connected as diodes are recommended (e.g. 2N4416, Q1-Q4 in Figure 1). The differential input voltage will be clamped to  $\pm 1.4V$ . This is sufficient overdrive to produce maximum power bandwidth.

**POWER SUPPLY PROTECTION**

Unidirectional zener diode transient suppressors are recommended as protection on the supply pins. The zeners clamp transients to voltages within the power supply rating and also clamp power supply reversals to ground. Whether the zeners are used or not, the system power supply should be evaluated for transient performance including power-on overshoot and power-off polarity reversals as well as line regulation.

Conditions which can cause open circuits or polarity reversals on either power supply rail should be avoided or protected against. Reversals or opens on the negative supply rail is known to induce input stage failure. Unidirectional transzorbs prevent this, and it is desirable that they be both electrically and physically as close to the amplifier as possible.

**STABILITY**

The PA98 is externally compensated and performance can be tailored to the application. Use the graphs of small signal response and power response as a guide. The compensation capacitor  $C_c$  must be rated at 500V working voltage. An NPO capacitor is recommended. The compensation network  $C_c R_c$  must be mounted closely to the amplifier pins 7 and 8 to avoid spurious oscillation.

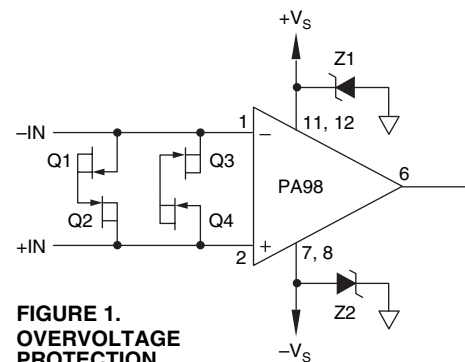

**FIGURE 1.  
OVERVOLTAGE  
PROTECTION**

## INTERNAL POWER DISSIPATION AND HEATSINK SELECTION

With the unique combination of high voltage and speed of the PA98, traditional formulas for heatsink selection will falsely lower the apparent power handling capability of this amplifier. To more accurately predict operating temperatures use Power Design<sup>1</sup> revision 10 or higher, or use the following procedure:

Find internal dissipation (PD) resulting from driving the load. Use Power Design or refer to Apex Applications Note 1, General Operating Considerations, paragraph 7. Find total quiescent power (PD<sub>Q</sub>) by multiplying 0.025A by V<sub>SS</sub> (total supply voltage). Find output stage quiescent power (PD<sub>QOUT</sub>) by multiplying 0.001 by V<sub>SS</sub>.

Calculate a heatsink rating which will maintain the case at 85°C or lower.

$$R_{OSA} = \frac{T_c - T_a}{PD + PD_Q} - 0.1^\circ\text{C/W}$$

Where: T<sub>C</sub> = maximum case temperature allowed

T<sub>A</sub> = maximum ambient temperature encountered

Calculate a heatsink rating which will maintain output transistor junctions at 150°C or lower.

$$R_{OSA} = \frac{T_j - T_a - (PD + PD_{QOUT}) * R_{\theta JC}}{PD + PD_Q} - 0.1^\circ\text{C/W}$$

Where: T<sub>J</sub> = maximum junction temperature allowed.

R<sub>θJC</sub> = AC or DC thermal resistance from the specification table.

Use the larger heatsink of these two calculations.

Power Design is an Excel spreadsheet available free from [www.apexmicrotech.com](http://www.apexmicrotech.com)